

WIRING DIAGRAM- ASPL-XXCW-DSMV

This document is complimentary to the SpeedLamp Instruction Manual (#21-322) and must be referenced after reading the manual. **IMPORTANT: There should be NO Power ever to the lampholders for any reason during installation!**

AC Primary Voltage: 120-277V

Parallel Connection Wiring Diagram (For retrofitting of signs with Instant-Start Ballast)

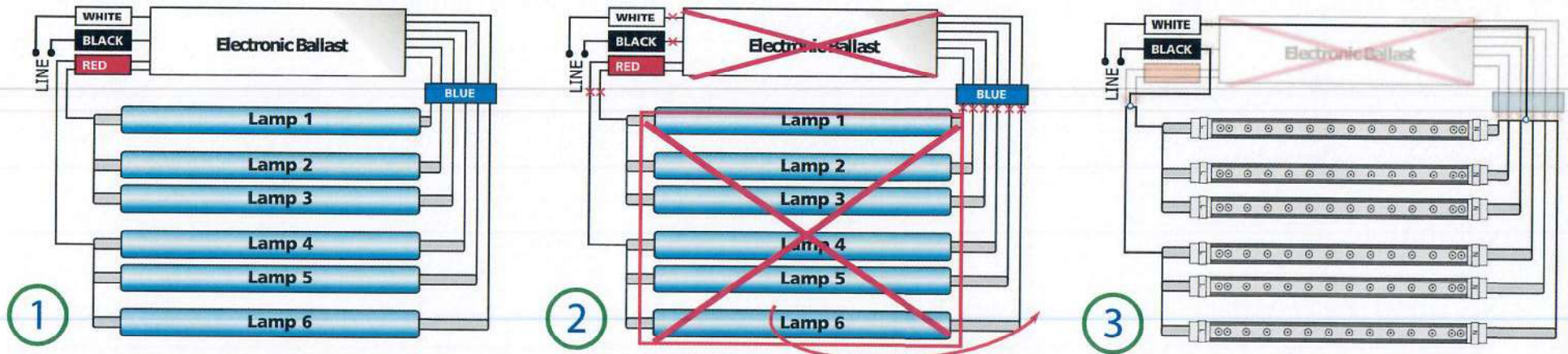

Series Connection Wiring Diagram (For retrofitting of signs with Rapid-Start Ballast)

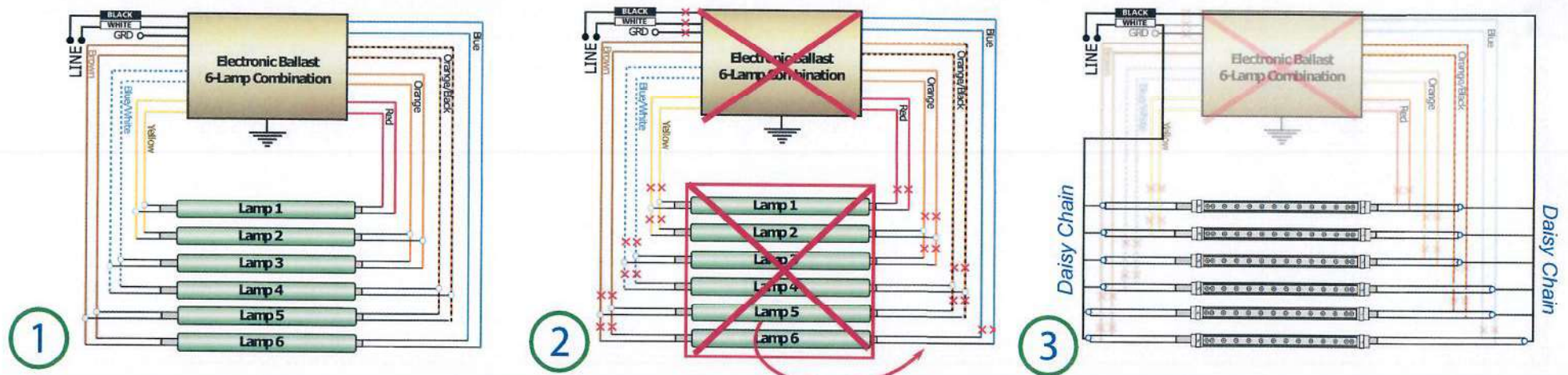

Instruction Manual - ASPL-XXCW-DSMV



Thank you for purchasing the Allanson SpeedLamp LED Replacement lamp. The retrofit process is straight forward and should be done following local electrical codes and standards.

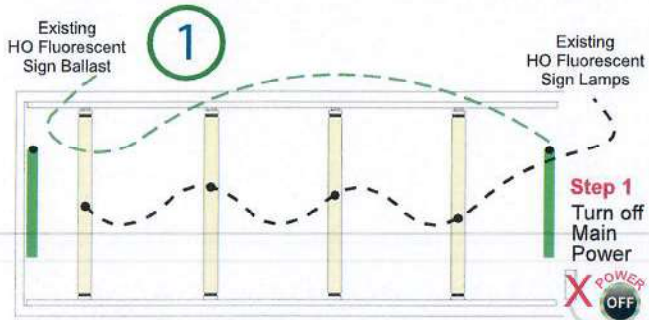

Step One: turn off main power to the sign or sign's branch circuit. In the event that there is no Disconnect Switch one should be added to meet code. Ensure proper grounding is bonded to the sign enclosure.

IMPORTANT: There should be **NO Power** ever to the lampholders for any reason during installation!

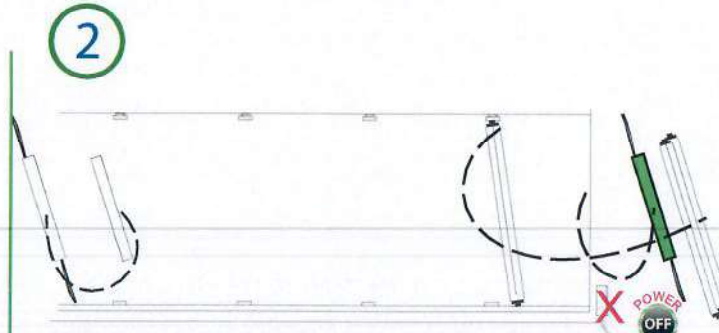

Step Two: remove all of the HO Lamps and Ballasts and dispose of them in accordance with local regulations. Do NOT disconnect existing wires from the lampholder terminals as you will need them again in step four.

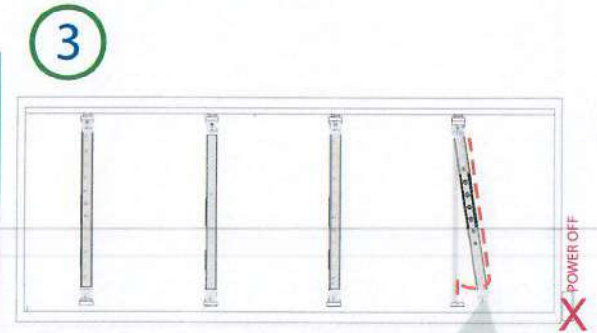

Step Three: install each SpeedLamp into the lampholders by inserting one end into the "spring lampholder" then compressing the spring enough to swing the lamp to the opposite end and into the fixed lampholder.

4 Parallel Connection Wiring Diagram

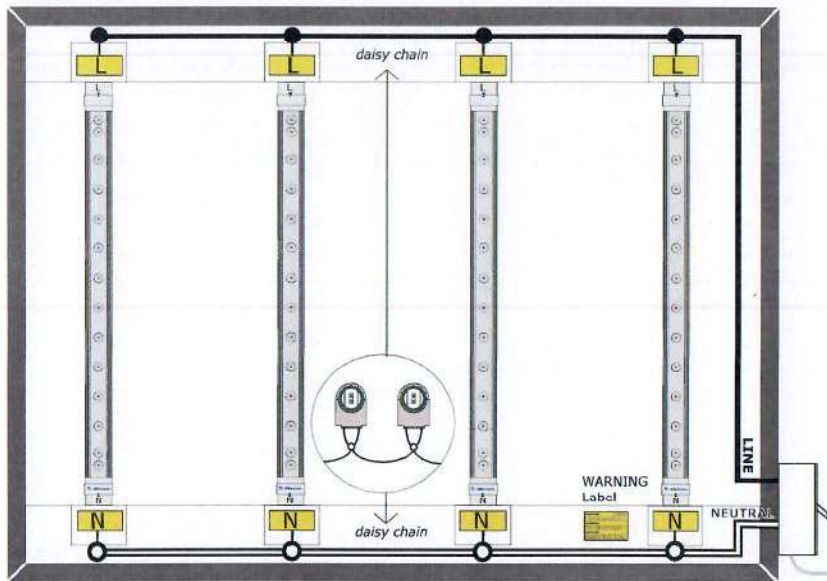

AC Primary Voltage: 120-277V

HOF Lampholder Re-Wiring

Electronic Ballast
Instant-Start

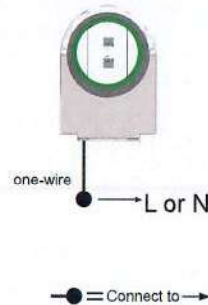

Electronic Ballast
Rapid-Start

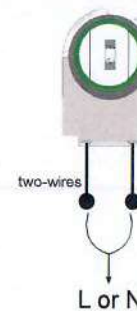

Step Four: re-wire the HOF lampholders. Ensure all lamps are oriented in a consistent manner, such that all sides of the lamp that are marked "LINE (L)" are connected into lampholders on the same side of the sign box and the "NEUTRAL (N)" sides are connected on the opposite side.



5

120-277Vac

WARNING

THIS LUMINAIRE HAS BEEN MODIFIED TO OPERATE DIRECT LINE-VOLTAGE LED LAMPS. DO NOT OPERATE FLUORESCENT LAMPS IN THIS LUMINAIRE.

AVERTISSEMENT

CE LUMINAIRE A ÉTÉ MODIFIÉ POUR FONCTIONNER AVEC DES LAMPES À DEL À TENSION DE LIGNE DIRECTE. NE PAS UTILISER DE LAMPES FLUORESCENTES DANS CE LUMINAIRE.

ADVERTENCIA

ESTA LUMINARIA SE HA MODIFICADO PARA UTILIZAR LÁMPARAS DE LED CON VOLTAJE DE LÍNEA DIRECTA. NO UTILICE LÁMPARAS FLUORESCENTES EN ESTA LUMINARIA.

L N

Step Five: Apply the yellow safety sticker, provided in the package, where directly visible (i.e. near the switch or on the raceway).



⚠ WARNING

READ THE FOLLOWING SAFETY INSTRUCTIONS BEFORE INSTALLATION

AC Primary Voltage: 120-277V

1. This product must be installed by qualified personnel familiar with electrical and sign installation techniques
2. The kit is to be installed in Listed Signs only
3. Tools required to do the LED installation: wire nuts, wire stripper, and wire cutter
4. Disconnect power at fuse box or circuit breaker before installation
5. This lamp is not intended for use with dimmers
3. This lamp is not intended for emergency lighting
4. Suitable for dry and damp locations. Suitable for use in enclosed luminaries
6. Examine all parts that are not intended to be replaced by the retrofit kit for damage and replace any damaged parts prior to installation of the kit
7. Do not disconnect existing wires from lampholder terminals to make new connections at lampholder terminals. Instead, cut existing lampholder leads away from the lampholder and make new electrical connections to lampholder lead wires by employing applicable connectors
8. **WARNING** - To prevent wiring damage or abrasion, do not expose wiring to edges of sheet metal or other sharp objects
9. Do not make or alter any open holes in an enclosure of wiring or electrical components during kit installation
10. Only those open holes indicated in the photographs and/or drawings may be made or altered as a result of installation of the kit
11. Two or more adjacent LED lamps shall not be mounted closer than 1 in. end to end or 4 in. side to side
12. **WARNING** -To avoid potential fire or shock hazard, do not use this retrofit kit with existing shunted bi-pin lampholders in the host sign. Shunted lampholders are found only in fluorescent signs with Instant-Start ballasts. Instant-start ballasts can be identified by the words "Instant Start" or "I.S." marked on the ballast. This designation may be in the form of a statement pertaining to the ballast itself, or may be combined with the marking for the lamps with which the ballast is intended to be used, for example F40T12/IS. For more information, contact the LED lamp retrofit kit manufacturer

IMPORTANT LABELLING INSTRUCTIONS

"THIS LUMINAIRE HAS BEEN MODIFIED TO OPERATE DIRECT LINE-VOLTAGE LED LAMPS. DO NOT OPERATE FLUORESCENT LAMPS IN THIS LUMINAIRE" shall be marked on the luminaire where directly visible to installers during relamping.

Please find the provided yellow safety label inside the product packaging.



**GENERAL PURPOSE
RETROFIT SIGN
CONVERSION
FOR USE ONLY IN
ACCORDANCE WITH
KIT INSTRUCTIONS**

KIT IS COMPLETE ONLY WHEN ALL PARTS REQUIRED BY THE INSTRUCTIONS ARE PRESENT



Installation Manual and Safety Instructions apply to the following part numbers: ASPL-18CW-DSMV, ASPL-24CW-DSMV, ASPL-30CW-DSMV, ASPL-36CW-DSMV, ASPL-42CW-DSMV, ASPL-48CW-DSMV, ASPL-60CW-DSMV, ASPL-64CW-DSMV, ASPL-72CW-DSMV, ASPL-84CW-DSMV, ASPL-96CW-DSMV, ASPL-108CW-DSMV, ASPL-117CW-DSMV, ASPL-120CW-DSMV

